

murano

orbis

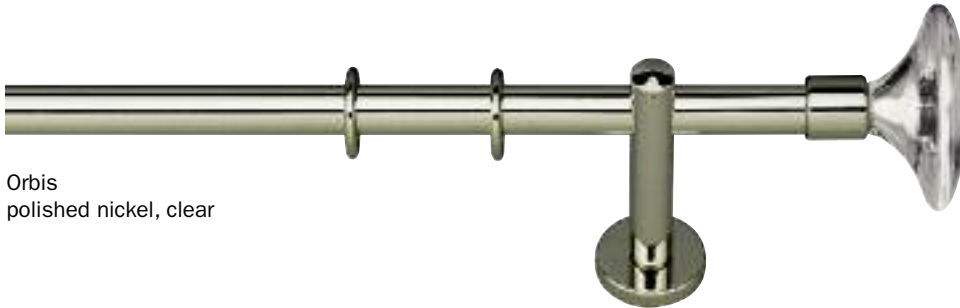

Orbis
polished nickel, clear

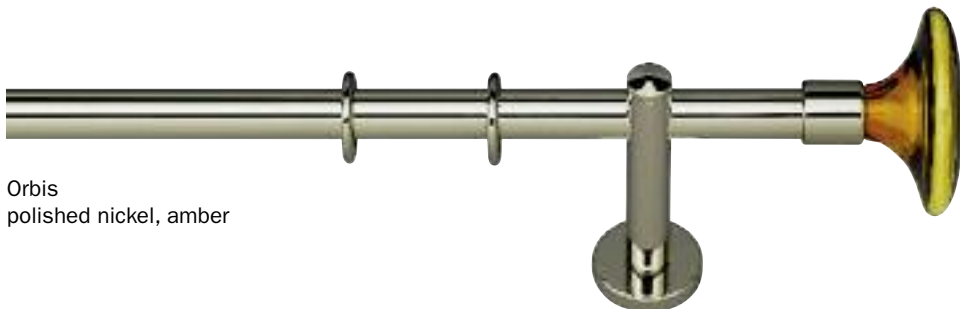

Orbis
polished nickel, amber

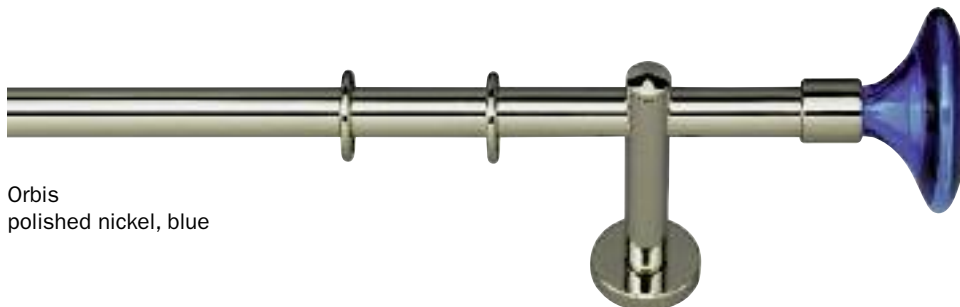

Orbis
polished nickel, blue

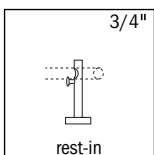

Pictured bracket is available in single or double format. Pass through brackets are only available when used in combination with standard rest-in brackets.



available rod diameter

ROBERT ALLEN

PRESENTS

B L ● M E

murano

orbis measurements

finial

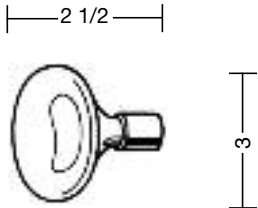

orbis

brackets

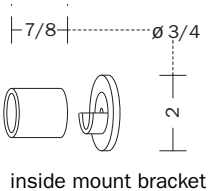

inside mount bracket

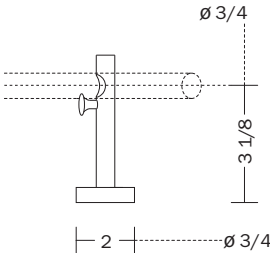

rest-in bracket

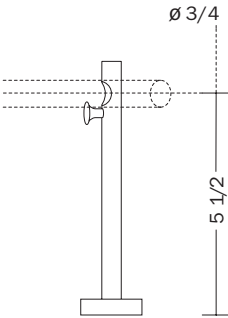

rest-in bracket extended

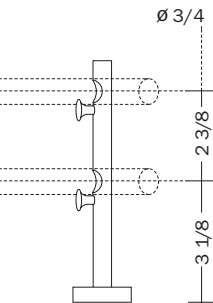

double rest-in bracket

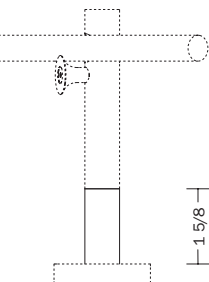

bracket extender (for rest-in bracket)

brackets

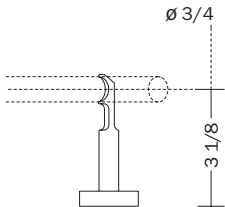

pass-through bracket

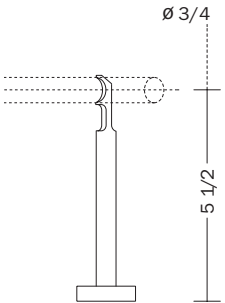

pass-through bracket extended

accessories

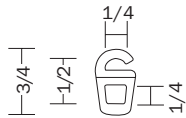

eyelet hook

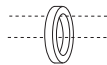

standard ring



c-ring

∅ = diameter of rod

All measurements above are listed in inches